

installfest



Hry v Linuxe



Hry v Linuxe

- Hry a Linux?
- Emulácia
- Predstavenie jednotlivých herných titulov
- Budúcnosť
- Otázky

Hry a Linux, hry a Windows

Linux

- Áno je to možné :-)
- 80% nekomerčné
- Malé vývojové štúdia
- Vysoká frekvencia vydávania
- OpenGL

Windows

- Väčšina hier je komerčných
- Veľké vývojové štúdia
- DirectX

Hry a Linux

- Množstvo hier (takmer) všetkých žánrov a veľkostí
- Nové tituly vznikajú prakticky každým dňom
- Čoraz častejšie sa objavujú aj komerčné hry, väčšinou multiplatformové (známe trio Linux, Windows a OS X)
- S rozvojom grafických prostredí prichádzajú aj čoraz graficky vyspelejšie hry.
- Hardvérová náročnosť stúpa
- Podpora výrobcov grafických kariet sa zlepšuje → dostupné sú aj uzavreté aj otvorené drivre.
- Objavujú sa aj prvé prenosné herné zariadenia bežiacie na Linuxe → Pandora

Emulácia hier a iných aplikácií

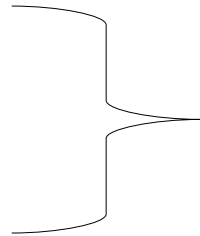
- Wine
 - Cedega
 - CrossOver
 - DOSBox
 - EPSXe – Playstation 1
 - E-UAE – Amiga
 - Fuse – ZX Spectrum
- Deriváty Wine
→ Komerčné
- 

Wine – trochu vínka nauškodí

- Názov je akronym – Wine Is Not an Emulator
- Umožňuje spustenie aplikácií napísaných pre Windows na X Window System
- Pre unix-like systémy → Linux, BSD systémy ...
- Verzia s označením 1.0 bola uvoľnená po 15 rokoch vývoja
- Absentuje DirectX
- Stránka Wine obsahuje databázu „spojazdnených“ aplikácií (WineDB), ktoré sú roztriedené do skupín podľa funkčnosti. Momentálne databáza obsahuje viac ako 7000 aplikácií, z toho bezproblémovo beží pod Wine niečo cez 1200.



archlinux

Verzia 0.9

Bezchybne
fungujúci SW



Nefungujúci SW

CrossOver a Cedega

- Komerčné deriváty Wine
- Obsahujú DirectX
- Podporované sú takmer všetky herné „ťaháky“ z windows

CrossOver

- Dostupný aj pre Mac OSX
- CO „špeciálne“ pre hry je oddelený od „kancelárskej“ verzi.
- Cena od 39 – 69 \$ (podľa verzie)

Cedega

- Len pre Linux
- Viac ako 1500 hier v databáze , z toho certifikovaných viac ako 40
- Cena za 1 rok je 45\$

Jednotlivé hry

- FPS a iné stieľačky
- Stratégie
- Zábavné klikačky a skákačky všetkého druhu
- Logické
- Niečo pre vedu
- Hry pre deti
- Hranie v terminály



FPS a iné strieľáčky

Trochu teórie na úvod...

- FPS (akronym First-Person Shooter) čiže strelačky z pohľadu prvej osoby patria bezosporu medzi najobľúbenejšie a najhranejšie
- Prvé FPS sa objavujú na začiatku 90. rokov → Wolfenstein 3D
- Po prvotnom úspechu nasleduje rozvoj → série Doom, Quake, Half-Life.
- Niektoré (a nielen) tieto hry na prelome tisícročí na Linux portovala spoločnosť Loki Software.
- Žiaľ, je potrebné konštatovať, že za ostatnými platformami FPS na Linuxe mierne zaostáva a to najmä v grafickom spracovaní.

Wolfenstein: Enemy Territory

- Je freeware nástupcom komerčnej hry *Return to Castle Wolfenstein*, pôvodne mala byť hra komerčným rozšírením *Return to Castle*.
- Nízke HW nároky (600 MHz CPU, 128 MB RAM, 32 MB g.k)
- Prostredie zasedené do 2. svetovej vojny
- Len Multiplayer → mnoho komunitných doplnkov, máp...
- 5 povolání za ktoré, je možné hrať, každé z nich je odlišné vlastnosťami a výzbrojov.
- Zaujímavá modifikácia *True Combat: Elite* → podobná CS



FIRETEAM: BRAVO

S Pvt RS

100 (D, 1)



14 14:26

Make Fireteam private?
Press 'F1' for YES, or 'F2' for No

! Allied team has destroyed the South Anti-Tank Gun!
! Allies have destroyed both Anti-Tank Guns!

100 HP 0 XP

30/60



Loading bay
Press (???) to hide
Destroy A or B

3:50
88 FPS

ILLU 210058 3
 KY
 MAX. GROSS 24,000 kg / 52,910 lbs
 TARE 2,180 kg / 4,806 lbs
 PAYLOAD 21,820 kg / 48,104 lbs
 CUBE 33.1 cu.m / 1,170 cu.ft

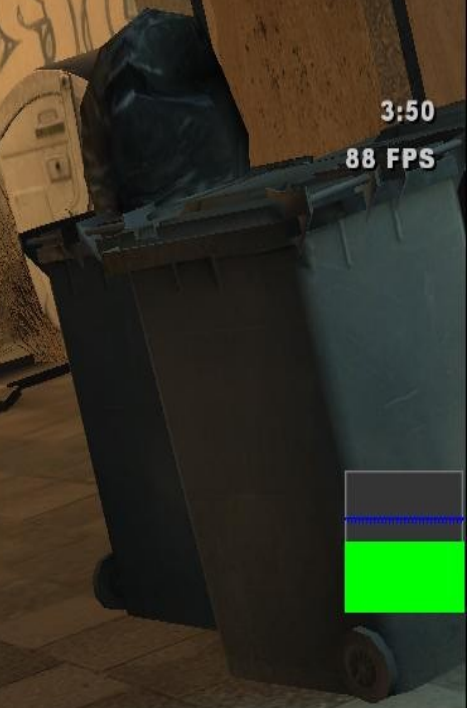

Auto 0 / 3

[C22]-Epepe <<< blablabla (AK-47)
[ImpreZ] Syoran <<< [Sheen]aBz (GRENADE)
[ImpreZ]AscalaphuS <<< Raoul_Duke (MP5/40)



Alley
Press (???) to hide
Destroy A or B

3:43
90 FPS

[ImpreZ]AscalaphuS [Canal Tunnel]:
Taking fire!
console: Raoul Duke drew first
BLOOD!
blablabla [Alley]: Contact!
gonzo|Bionic@nosound: Init is a
true ladies man
Abrlek [Alley]: Contact!



Auto [] /3



ASSAULT CUBE

- AC je postavený na *Cube Engine*
- Inštalačný súbor má cca 40 MB
- Primárne zameraný na sieťový Multiplayer → komunita
- Súboj teroristov a policajtov, v podstate bez príbehu
- Nízke HW nároky
- Ľahko sa edituje, možnosť pridávať vlastné zbrane, mapy...
- Vysoká hrateľnosť

teh_ownerer fragged Bluesman
where_am_i fragged Killer
you fragged Tuborg
you fragged chibby



1



4 / 10

Creating bot...
connected: fried circuits
Creating bot...
connected: SoUIFaThEr
Creating bot...
connected: Dead man



 100

 30/60

Warsow

- Futuristická FPS
- Postavená na *Qfusion 3D engine* → modifikácia Quake 2 GPL engine
- Z postáv je na výber z rôznych „potôr“
- Zaujímavá je najmä komixová grafika
- Množstvo fínt v pohybe, rôzne triky
- Zastúpený je najmä multiplayer
- Mierne vyššie HW nároky hlavne na grafickú kartu
- Veľkosť inštalačného súboru je cca 185 MB

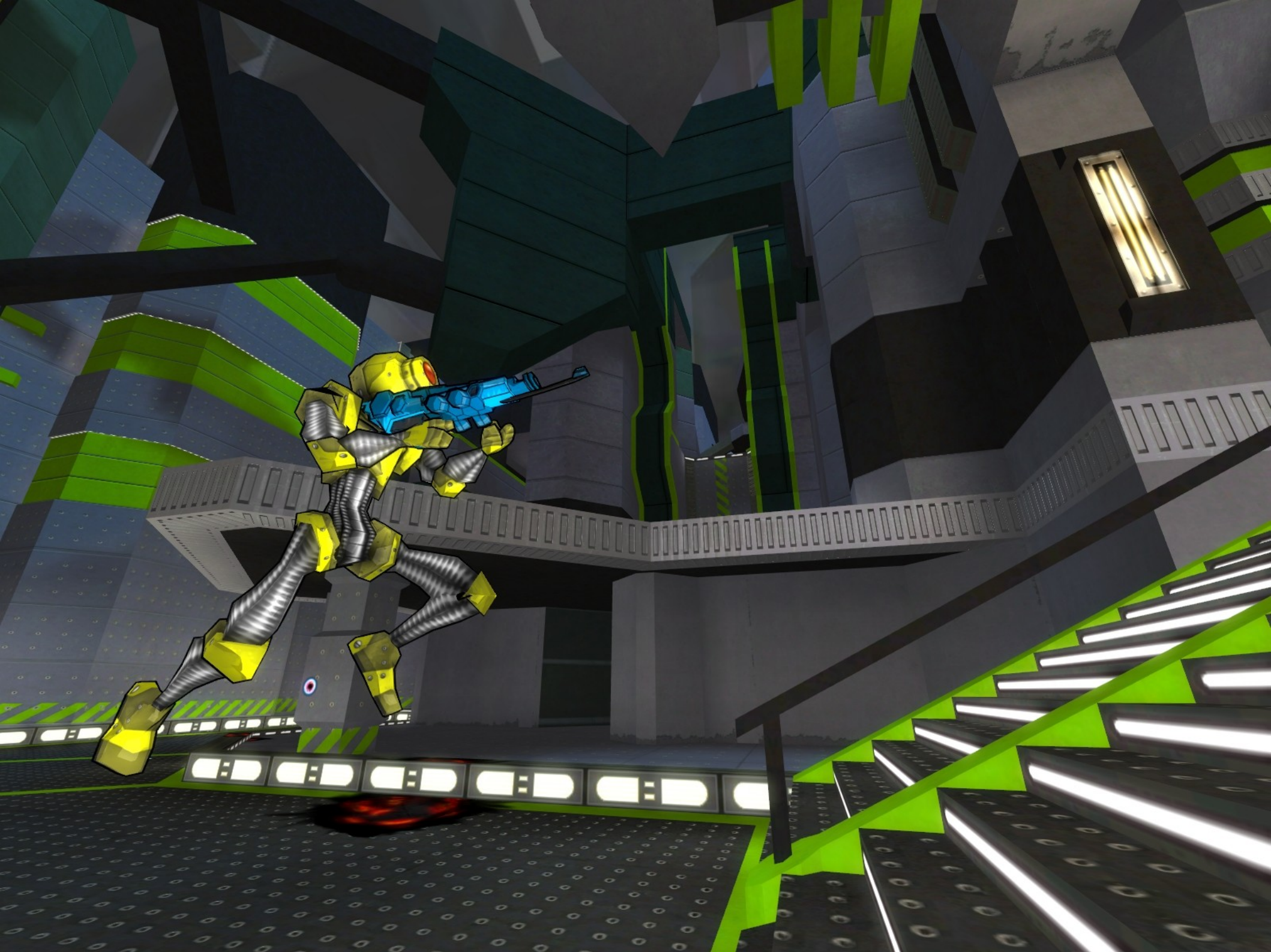



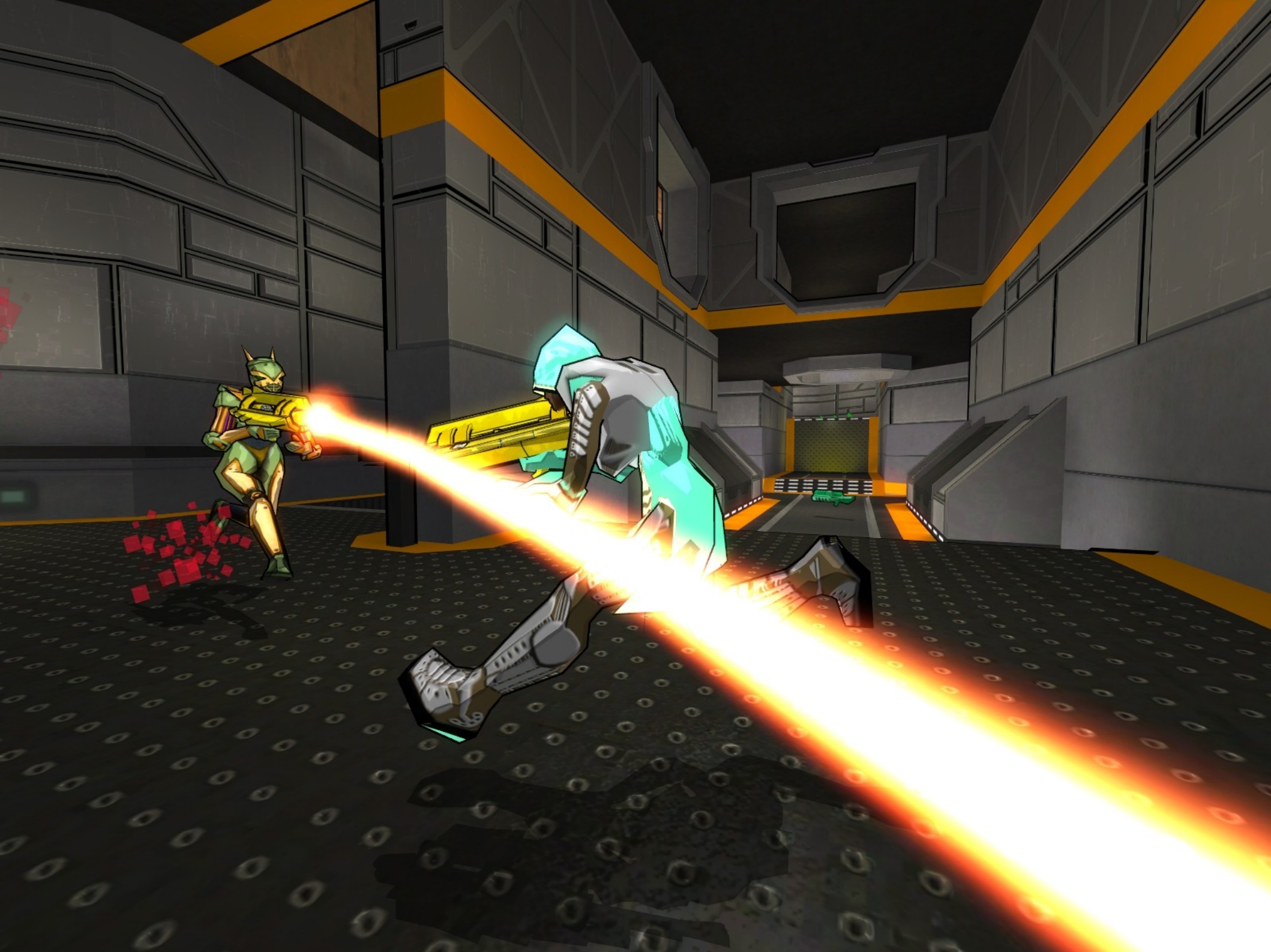

Alien Arena



- Veľmi podobná Quake, Doom
- Temné prostredie
- Boj s mimozemšťanmi
- Absencia príbehu



ALIEN ARENA

2007

FRAG 0

DEATH 0

LEADER 0



100% Laser



HEALTH 100 AMMO ARMOR

Smokin' Guns



- Westernová 3D akcia
- Je použitý *Quake III Arena Engine*
- Veľmi dobre je spracované prostredie a modely zbraní
- Primárne zamerané na MP
- K netradičnému prostrediu patria aj netradičné herné módy → bank robbery, duel ...
- Prakticky hra bez príbehu
- HW nároky sú primerané
- Inštalačný súbor je veľký cca 340 MB



Press "FIRE" to change to the next player
Press "FIRE2" to change to the previous player

3:15

You hit Clint's neck and head.
hahahappy killed Clint with Winchester 1897.
Your head is hit.

hahahappy

Clint

hahahappy

Sentenza



0 2 2

30 21 13

0 9

Counter-Strike 2D

- Takmer presná 2D kópia veľkého brata
- Obsahuje rovnaké zbrane, mapy ako v CS ibaže v 2D
- Zameraná hlavne na multiplayer
- Množstvo máp
- Vysoká hrateľnosť a zábava
- Nízke HW požiadavky a iba cca 5MB inštalačný súbor

Unreal Software's Counter-Strike 2D

& no login data stored

Console

New Game

Find Servers

Friends

Chat

Options

Editor

Help

Quit





[Pwn3] johny xD [PL]: next rund
ugur: noü
inkvizitor "DEAD*": FUCKING 4ITERS

Menu

Map

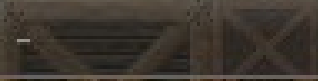

Free Look

11 FPS, Buffer: 0 ms
1 Con., up: 97, down: 2416

[RUS]-Dim@1~ M4A1 MiqRoP_574@hotmail.com
=!KENT!=(RUSSIAN)[PzN] Deagle [RUS]-Dim@1~
||H.Core-T||~>.<~-[K-] AK-47 K@7eR!n@

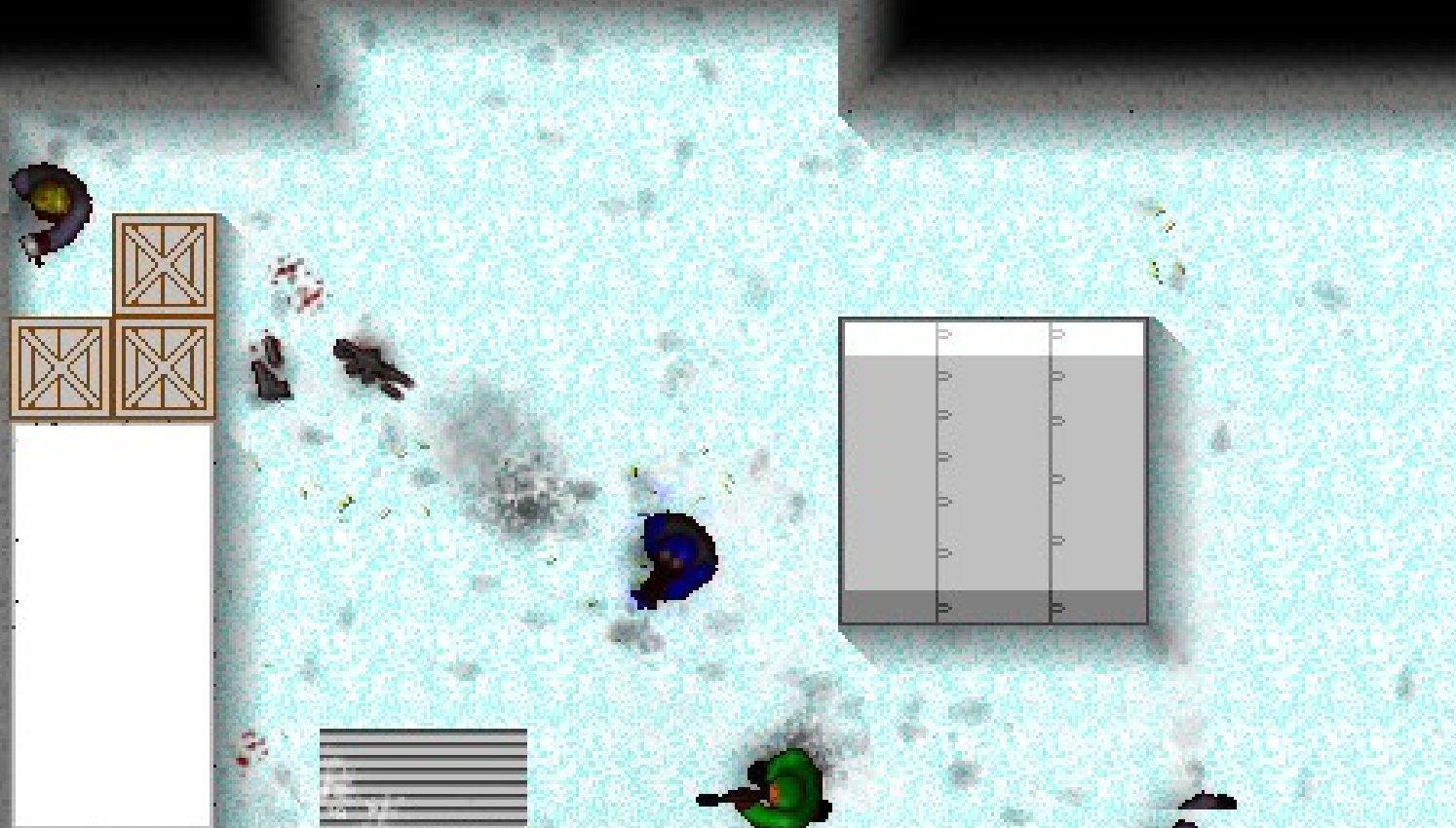

FAUST(RUS) (Radio): Fire in the hole!

installfest



Stratégie

Glest

- 3D real-time stratégia
- Boj dvoch znepriatelených táborov – tech (ľudia) a magic (mágovia)
- Hra obsahuje aj multiplayer, zoznam serverov nie je dostupné formou server-listu ale ja potrebné sa pripojiť na konkrétnu IP
- Maximálne 4 hráči na mapu
- Množstvo jednotiek, budov a rozmanitosť prostredia....
- Špecialitou sú technické jednotky → lietadlá, vzducholode, katapulty...
- Veľkosť inštalačného súboru len okolo 55 MB

150/170(+24) 666/2000 825/1500 390/1600



0/150(-28)

500/2000

500/1500

500/1200

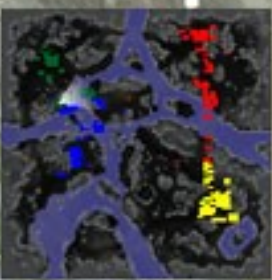

Glest

TECH FACTION

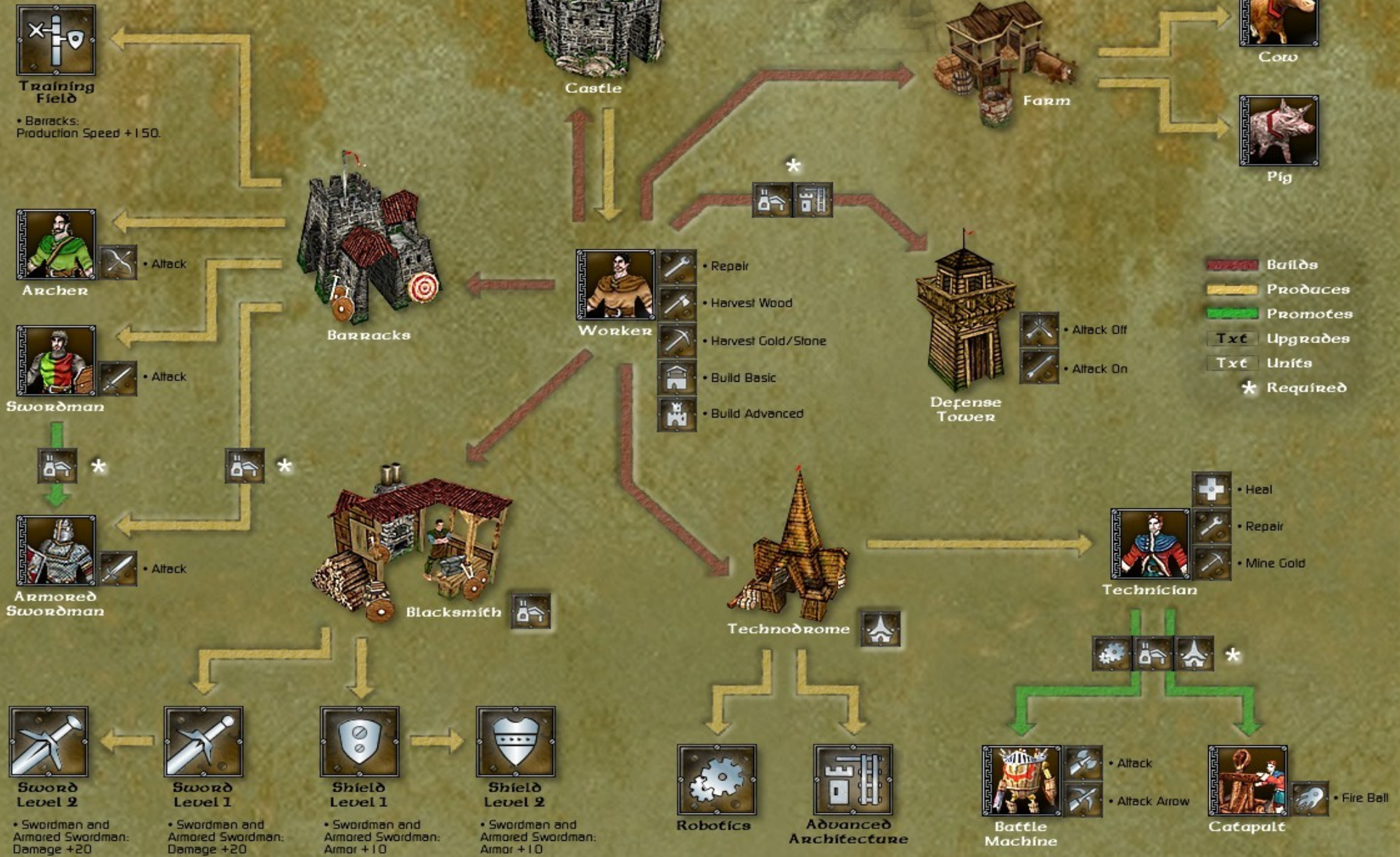



Battle for Wesnoth



- Ťahová stratégia
- Dostupné takmer pre všetky možné aj nemožné systémy
- Kompletne preložené do češtiny a na 80% preložené do slovenčiny
- Bohatý singleplayer aj multiplayer
- Množstvo rás a jednotiek
- V celej hre ide vlastne o získavanie dedín a splnenie úlohy zadanej v kampani
- Každá jednotka je špecifická svojimi vlastnosťami a to výrazne ovplyvňuje stratégiu



Životy
9/33
Skúsenosť
7/23

Glyn
Pytliak
Človek
úroveň 1
chaos
inteligentný, silný

pohyb: 0/5
4-2 dýka
zblízka--sečný
4-4 luk
na diaľku--bodný

Koniec kola

Zaútoč na súpera



Elfská druidka

Úroveň 2

neutrál

verný, inteligentný
lieči, uzdravuje +8

Profil

Nerelia

Životy: 36/36

Skúsenosti: 0/64

Chodiaca mŕtvola

Úroveň 0

chaos

nemŕtvý, nebojácny, weak



Životy: 18/18

Skúsenosti: 0/24

Profil

Vyber si zbraň:



palica

4-2 (60%)

- zblízka -

dotyk

5-2 (60%)

choroba



lapenie

6-2 (60%)

- na diaľku - 0-0 (0%)

spomaľuje



tŕne

6-3 (70%)

- na diaľku - 0-0 (0%)

magický

Výpočet zranenia

OK

Storno



Životy

36/36

Skúsenosť

0/64

Nerelia

Elfská druidka

Elf

úroveň 2

neutrál

verný, inteligentný

lieči, uzdravuje +8

pohyb: 0/5

4-2 palica

zblízka-tupý

6-2 lapenie

na diaľku-tupý

spomaľuje

6-3 tŕne

na diaľku-bodný

magický

Koniec kola

Regnum Online

- MMORPG (akronym Massive(ly)-Multiplayer Online Role-Playing Game) stratégia
- Regnum v latinčine znamená kráľovstvo ↓
- Tri kráľovstvá → Alsius -horské a chladné
→ Ignis -vyprahnuté
→ Syrtis - „zelení“
- Základom je zbierať skúsenosti (napr. plnením questov) a prelúskavať sa do ďalších levelov.
- Krajina je rozdelená do 3 zón podľa náročnosti hrania



Play

Create character

Delete character

Credits

Exit



REGNUM
— ONLINE —

Nordo Archer Level 1

9

758 / 920
310 / 310

Orc

Challenging



- You've attacked Orc: Normal hit [15 damage]
- You've attacked Orc: Critical hit [26 damage]
- Orc has attacked you: Normal hit [83 damage]
- You've attacked Orc: Normal hit [14 damage]

Syrtis global General



Beginner's area

Warzone

Inner realm



Klikačky a skákačky



- Komerčná hra
- Cena 20\$ → cca 16 € → cca 450 Kč
- Spájanie guľôčok, vytváranie štruktúr a následné vysatie
- V rámci fyzikálnych zákonov
- Stavanie čo najvyššej veže on-line
- Zaujímavo spracovaná grafika a animácie

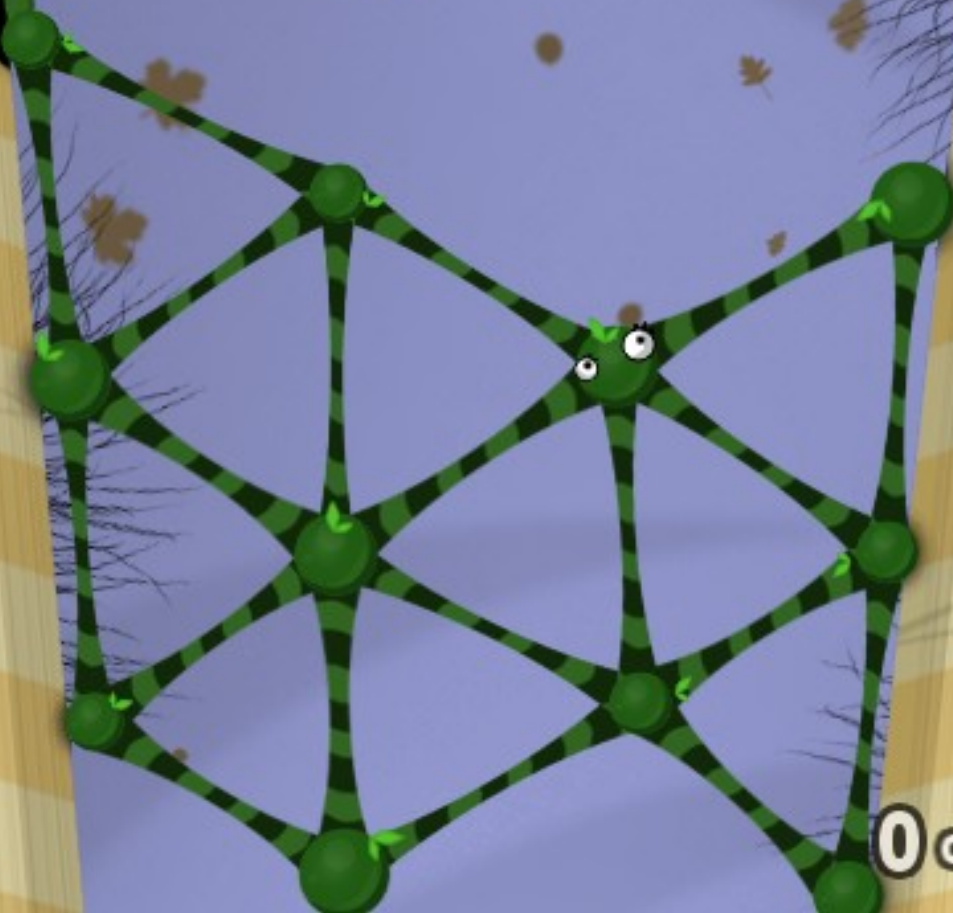

retry

0 of 2 collected menu

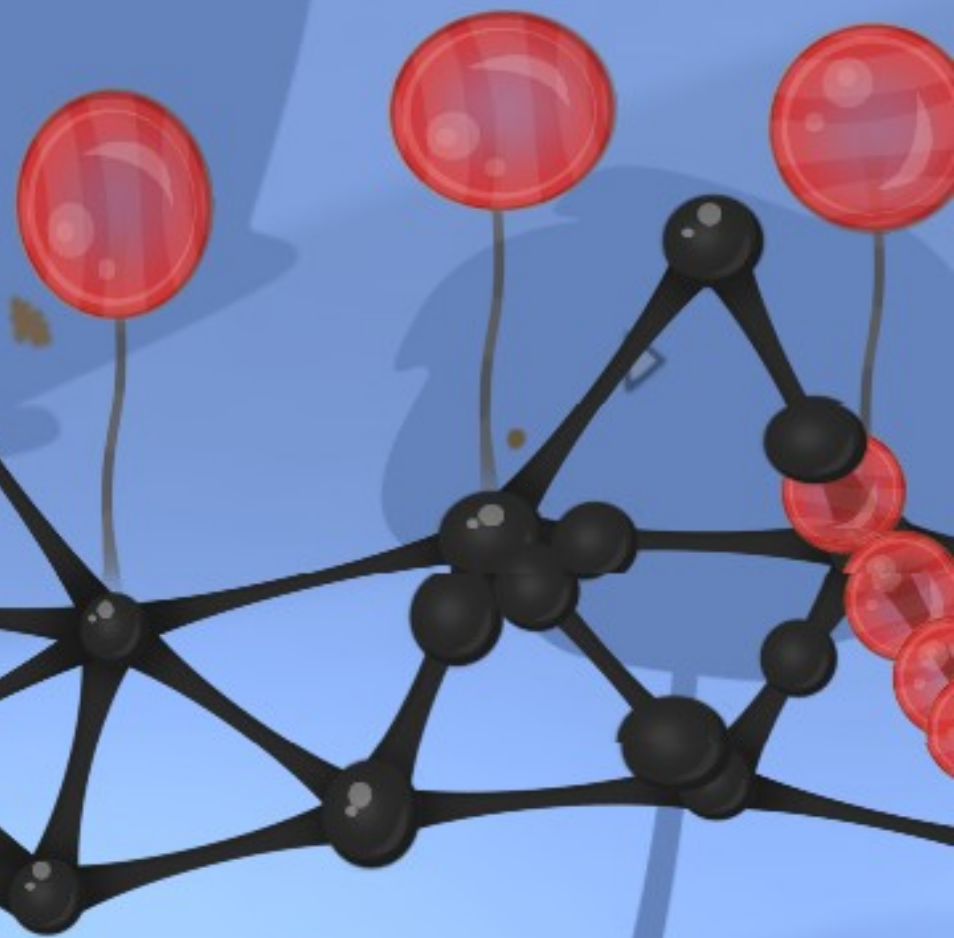

retry

0 of 6 collected menu

9.3 meters high

using 56 of 56 Goo Balls

189131 tallest in the world



exit

Supertux

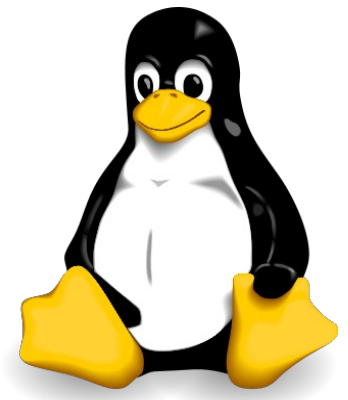

- Klasická skákačka
- Veľmi podobné hre Supermario (až príliš :-))
- Mnoho levelov
- Vysoká hrateľnosť
- Vstavaný editor levelov
- Nízke HW nároky
- Veľmi zábavné

SCORE 0

TIME 186

COINS 0

LIVES 5

FPS 20.2



SCORE 0

COINS 0

LIVES 5



Oh no! More Snowballs!

Teeworlds

- Systém hry na spôsob Worms
- Zamerané na Multiplayer hoci neabsentuje ani SP
- Boj guľôčok
- Rýchla
- Mnoho zbraní
- Pomerne početná hráčska komunita





3:54

ghost monkey Chocolate med Løg



*** hahahappy entered and joined the red team

208

.:ironman:. sexybudy

5

Internet

LAN

Settings

Quit

Name:

- Dynamic Camera
- Switch weapon on pickup
- Show name plates
 - Always show name plates
- Custom colors

Skins



saddo



bluestripe



coala



default



limekitty



warpaint



toptri



twintri



redbopp

Player

Controls

Graphics

Sound

Mystic Mine

- Komerčná hra - Cena 15 \$ → cca 16,3 € → 430 Kč
- Prostredie divokého západu
- Základný cieľ: spleťou výhybiiek zozbierať s vozíkom čo najviac mincí
- Časom pribúdajú ďalšie ciele → hold the lamp, prehadzovanie bomby ...
- Viac ako 200 levelov
- Vhodné pre všetky vekové kategórie
- Systém automatickej obtiažnosti
- Multiplayer na jednej klávesnici → na ovládanie hry je potrebná len jedna klávesa
- Max. 6 hráčov na jednej klávesnici

Collect the most coins



	3
	2
	1
	0
	0
	0

Menu





skill: Amateur (60)



Hold the Lamp



Gain 68 points in 120 seconds



installfest



Logické hry

Logické hry

- Veľké množstvo
- Najmä malé projekty
- Rôzne skladačky, puzzle, niektoré spoločenské hry....
- Tvoria väčšinu obsahu Gnome hier

Nimuh

- Cieľom je predstavenie španielskeho autonómneho územia – Andalúzie
- Zaujímavý „mimozemský príbeh“ (Nimuh je mimozemšťan)
- Herná plocha je bludisko z ktorého, má Nimuh vyjsť
- Humorné spracovanie
- Podporovaný Európskym fondom regionálneho rozvoja



5/40

00:21

Options menu with buttons: <<, OPTIONS, >>, RESTART, QUIT

Huelva

Huelva



Huelva

Famed without doubt for the discovery of America, when Christopher Columbus set sail from the port of Palos de la Frontera, arriving on a Caribbean island on the 12th October 1492. Huelva has one of the busiest and fastest growing ports in Spain.

Objective

The statue of Columbus is the objective for this province.

Continue



Phun

- Študentský projekt
- Platia tu fyzikálne zákony
- Nekonečno variácií
- Vhodné na vyblbnutie :-)

Phun beta 3.5

File...
Options...
Zoom: 0.21x
Help!

Control

||
◀ Undo
sim start
▶ Redo

PARKEYS
ARRR
SS
W
KEYS

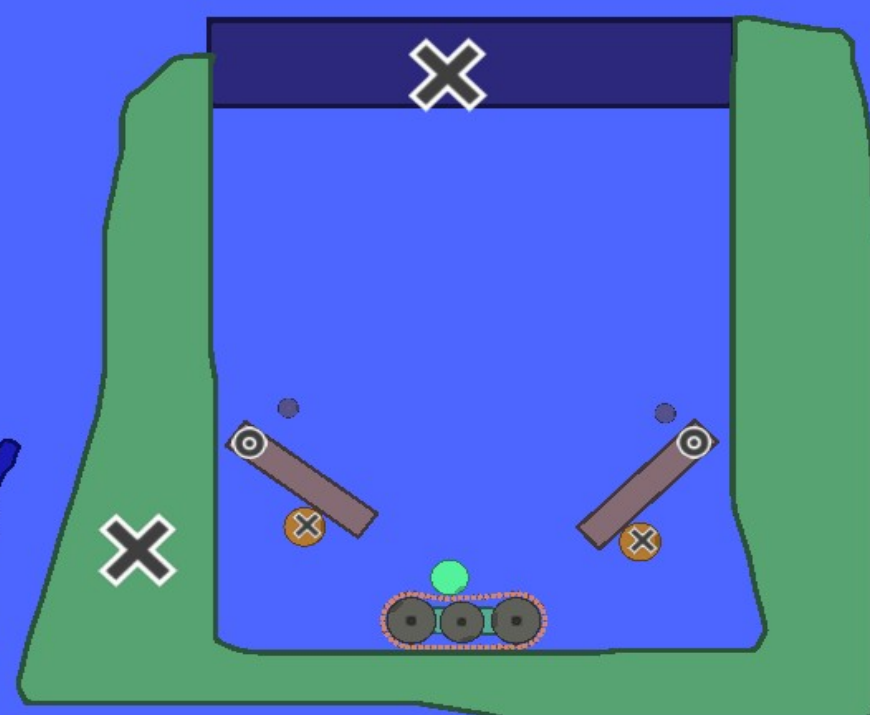

Toolbar

- Brush
- Drag
- Plane
- Circle
- Box
- Chain
- Spring
- Fixate
- Hinge

Options

- Gravity
- Air friction
- Left mouse click opens popup
- Draw inside objects
- Speed: 1.00x
- Enable shaders (fancy graphics)
- Simple water rendering
- Draw Hinges/Fixes when running
- Draw clouds
- Object borders

Undo Redo Zoom: 0.88x

sim start



Ďalšie logické hry

- Tetravex
- Mahjongg
- Gnometris (kópia tetris)
- OpenAlchemist
- Fish Fillets
- FloboPuyo
- Lagano
- Gnobots (roboti)
- ...

installfest



Niečo pre vedu

Foldit

- Skladanie priestorových štruktúr bielkovín
- Všetky takto poskladané varianty sa zasielajú Washingtonskej univerzite
- Výsledky môžu pomôcť pri objasňovaní Rakoviny, HIV a Alzheimerovej choroby.
- Veľmi pekný grafický kabátik
- Multiplatformová
- Closed Source → nie je možné nazrieť do zdrojových kódov

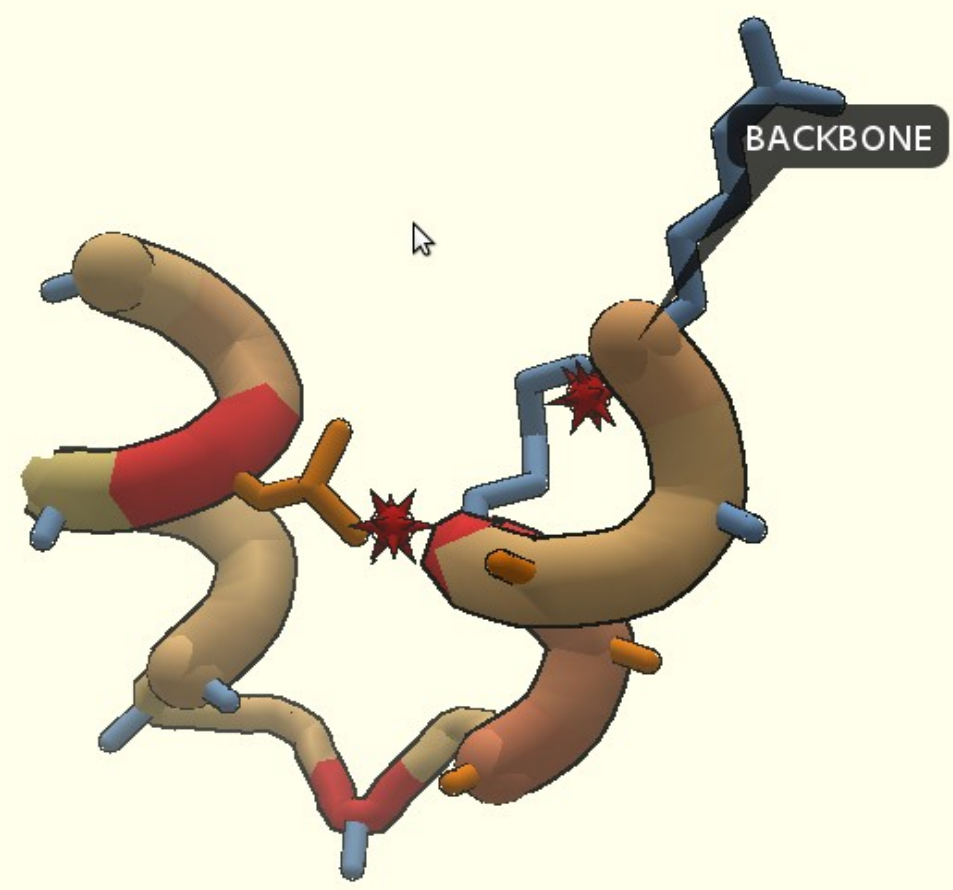

This **clash** can't be fixed moving **sidechains** alone!
Try pulling on the protein's **backbone**.





▼ Group Competition

#	Group Name	Score

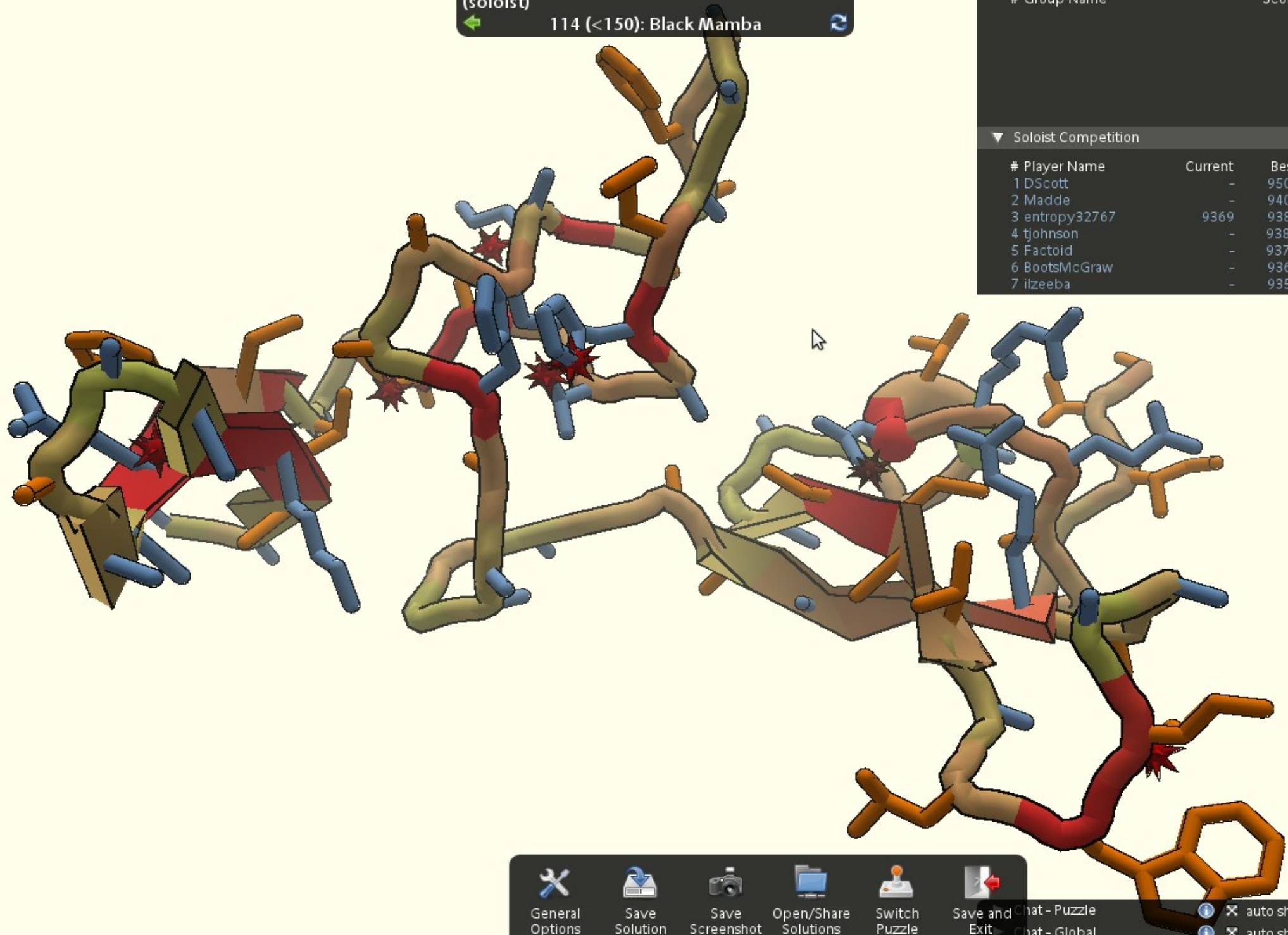
▼ Soloist Competition

#	Player Name	Current	Best
1	DScott	-	9506
2	Madde	-	9405
3	entropy32767	9369	9385
4	tjohnson	-	9380
5	Factoid	-	9379
6	BootsMcGraw	-	9368
7	ilzeeba	-	9352



 General Options
  Save Solution
  Save Screenshot
  Open/Share Solutions
  Switch Puzzle
  Save and Exit

Chat - Puzzle  auto show
 Chat - Global  auto show
 Notifications  auto show

installfest



Niečo pre deti

Omnitux

- „Balíček“ hier
- Vhodné pre deti predškolského veku
- Rôzne úlohy na počítanie, rozpoznávanie farieb, orientáciu na mape, puzzle
- Naučí aj jazyky (poľsky, francúzsky a anglicky) → aj hovorená časť
- Skvelá ergonómia ovládania
- Ako odmena za každú splnenú úlohu Tux



Instruments de musique



A musical staff with a treble clef, a key signature of two sharps (F# and C#), and a 3/4 time signature. The melody consists of a quarter note G4, a quarter note A4, and a quarter note B4. A penguin character with a large question mark on its chest is positioned in the center of the staff. Below the staff are two blue speakers. The dynamic marking *mf* is written below the first speaker.



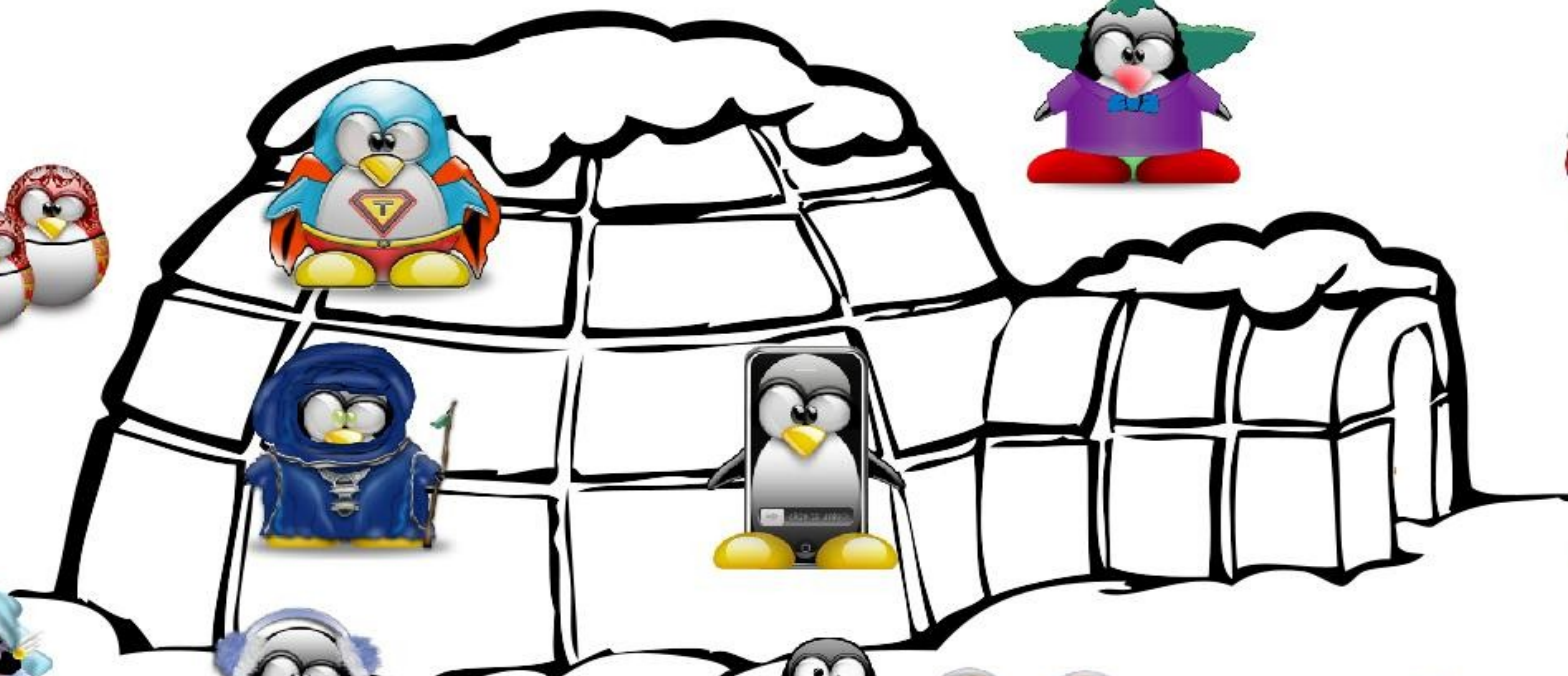

installfest

A progress bar consisting of 20 vertical rectangular segments. The first 14 segments are filled with a solid green color, while the remaining 6 segments on the right are empty, showing only the green outline.

Terminal gaming

Freesweep

```
simon@simon-desktop: ~  
Súbor  Upraviť  Zobrazit'  Terminál  Karty  Pomocník  
1 0 - - - - -  
1 2 1 1 1 1 1 1 - 0 - - - - -  
0 - 0 1 1 1 - - - - - 0 - -  
- - - 1 2 0 - - - - - - - -  
- - - 1 2 0 - - - - - <*> - - 0  
0 - 0 2 1 1 1 2 0 - - - 0 -  
- - - 0 2 1 1 1 2 - - 1 - - -  
- - - - - 0 1 1 0 - - 0 - - -  
- - 0 - - 1 1 1 3 0 - - - - -  
- 0 - - - 1 1 2 2 1 3 0 - - - -  
0 2 1 1 0 1 1 0 0 2 1 3 0 - - -  
1 1 1 1 1 1 3 - - 0 - - - - -  
1 0 - - - 0 - 0 - - - -  
-- FreeSweep --  
by Gus! & Psilord  
Hit '?' for help  
Time: 2s  
Loc: 14, 4  
Mines: 30  
Marks: 0  
Percentage: 0.00%  
BOOM! Any key to continue, 'q' to quit.
```

Bastet



Sinflate

level: 3 -*- ships: -*- aliens: 3 -*- score: -241

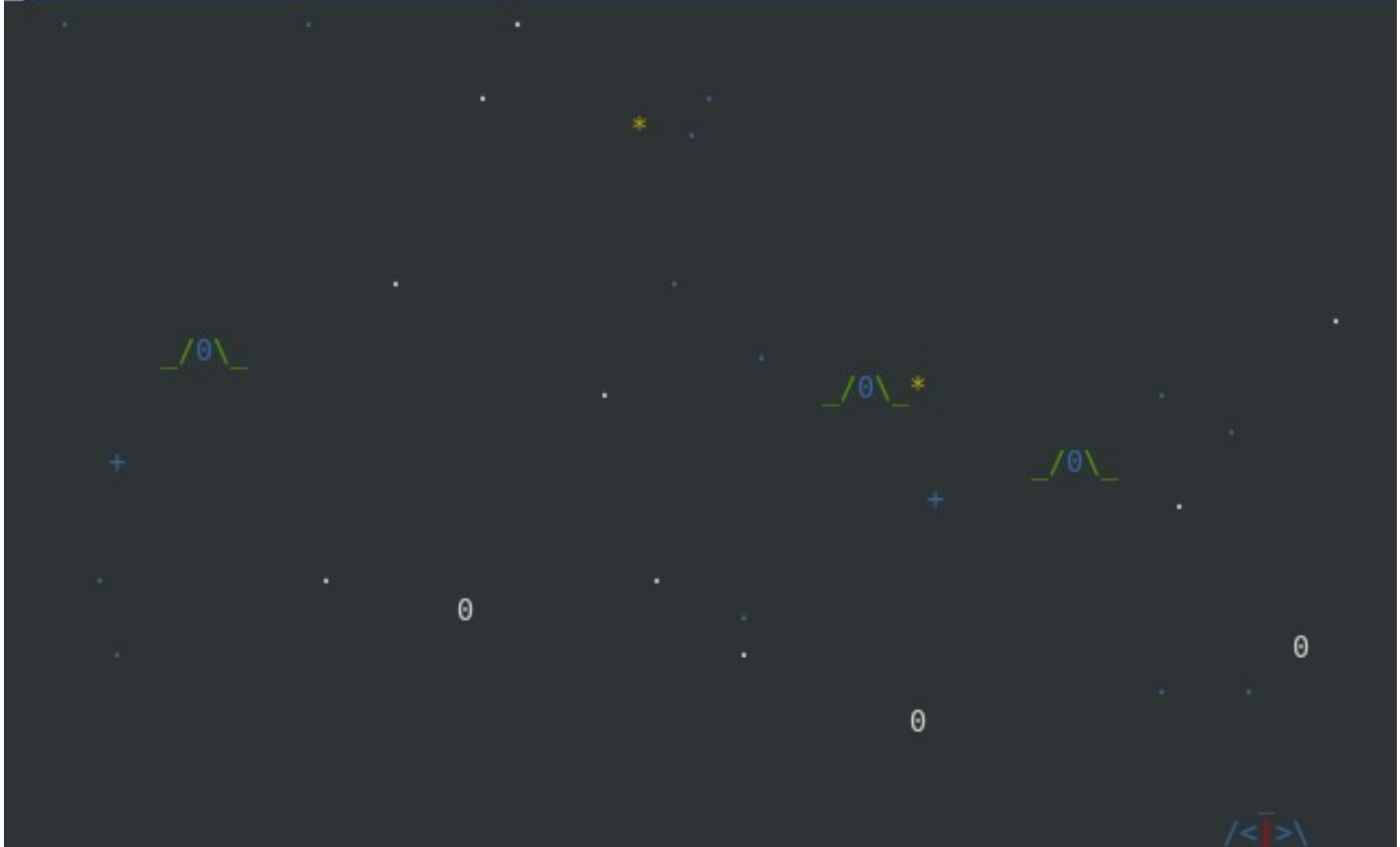

Freecell

```
space #1780786633 enter
[ 3h][11d][ 6s][ 8h] (= [ ][ ][ 1c][ ])
  w    x    y    z

   1d  12d  13h  12s  9c  4c  4h  3d
   2d   6h   8d  10s  5d  5c  9s  1s
   2s   1h   9d   4s  13c 12h  5s 10h
   8c   4d   2c   8s  10d 13s  3c 13d
   7c  12c   6d  11h   3s 11s 10c  6c
   2h   5h   7h   7s  11c           9h
   7d

   a    b    c    d    e    f    g    h
quit undo ?=help          4 moves, 0 undos
```

Tornado



Budúcnosť...

- Dve možné varianty

A) Rozšírenie Linuxu

- veľké komerčné hry
- kvalitnejšie Open Source hry

B) Stagnácia, prípadný pokles rozšírenia Linuxu

- Rozvoj menších komerčných hier (do 20\$)
- Open Source hry zostanú na približne rovnakej úrovni

Zdroje

- Za povolenie na použitie niektorých obrázkov ďakujem



- Wikipedia
- wiki.ubuntu.cz
- happypenguin.org
- tce-czsk.net
- Stránky jednotlivých projektov

installfest



Otázky ?

installfest